

S7 Hoch mit Lina GT 4551 s

Speicherstein



Abbildung: S7 Hoch mit Lina GT 4551 s
Oberflächenveredelung:
Camina Silikatanstrich in Kombination
mit Designbeton

Abbildung: S7 Hoch mit Lina GT 4551 s
Oberflächenveredelung: Camina Silikatanstrich



Standard



Gesamtgewicht



Kamineinsatz

Lina GT 4551 s
NW-Leistung: 5 kW
Abgasutzen: Ø 160 mm

Optional



Mehr Infos unter
camina-schmid.de

Zubehör



Speicherbeton



Speicherbeton



Designbeton

Frontansicht M 1:20

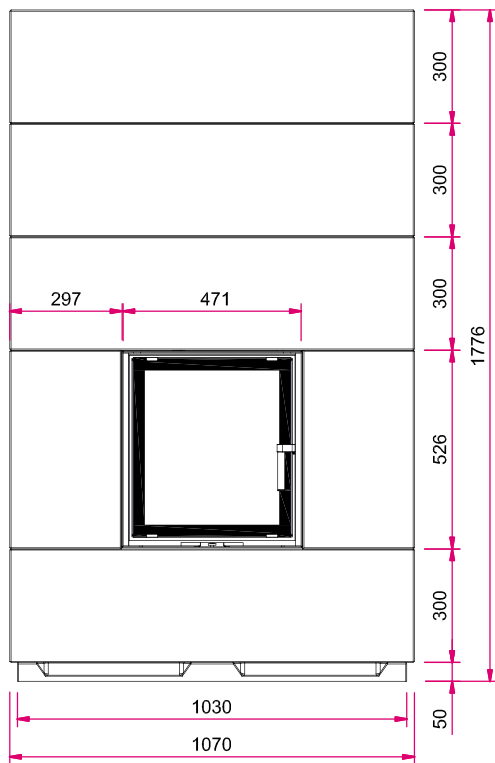

Seitenansicht links M 1:20

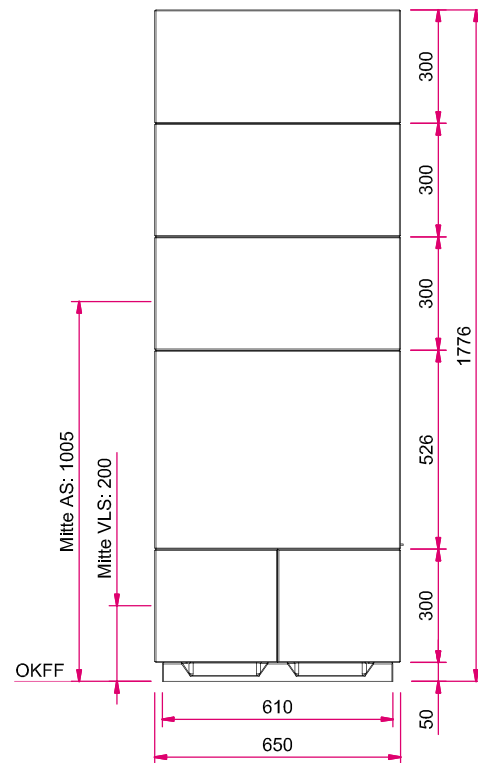

Hinweis: Mit optionalem Zubehör bitte die Angaben in den Preislisten beachten.
AS: Abgasstutzen, VLS: Verbrennungsluftstutzen, OKFF: Oberkante Fertigfußboden

Draufsicht M 1:20

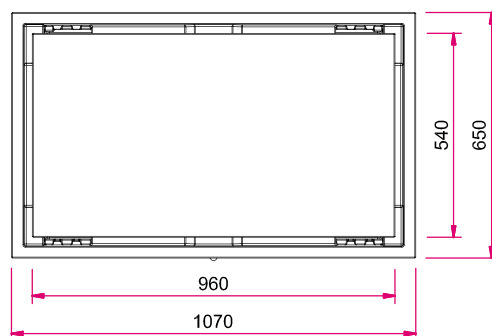

S7 Hoch mit Lina 4551 s

Speicherstein



Abbildung: S7 Hoch mit Lina 4551 s
Oberflächenveredelung:
Camina Silikatanstrich in Kombination
mit Designbeton

Abbildung: S7 Hoch mit Lina 4551 s
Oberflächenveredelung: Camina Silikatanstrich



Standard



Gesamtgewicht



Kamineinsatz

Lina 4551 s
NW-Leistung: 7 kW
Abgasstutzen: Ø 180 mm

Optional



Mehr Infos unter
camina-schmid.de

Zubehör



Speicherbeton



Speicherbeton



Designbeton

Maßzeichnungen S7 Hoch mit Lina 4551 s

Frontansicht M 1:20

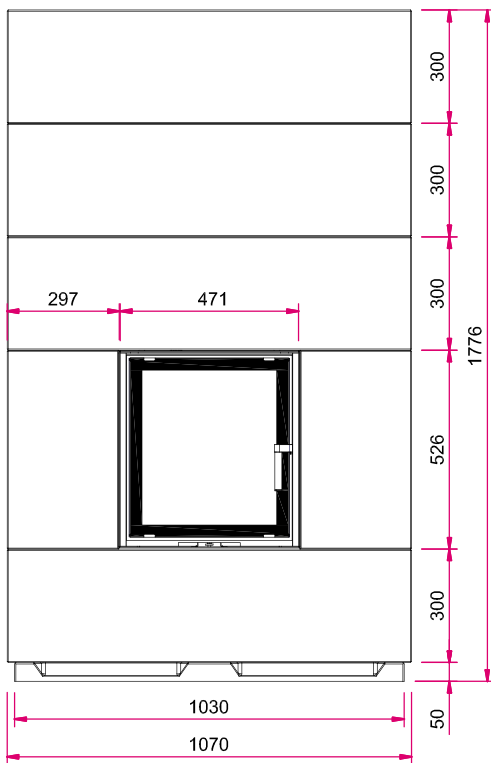

Seitenansicht links M 1:20

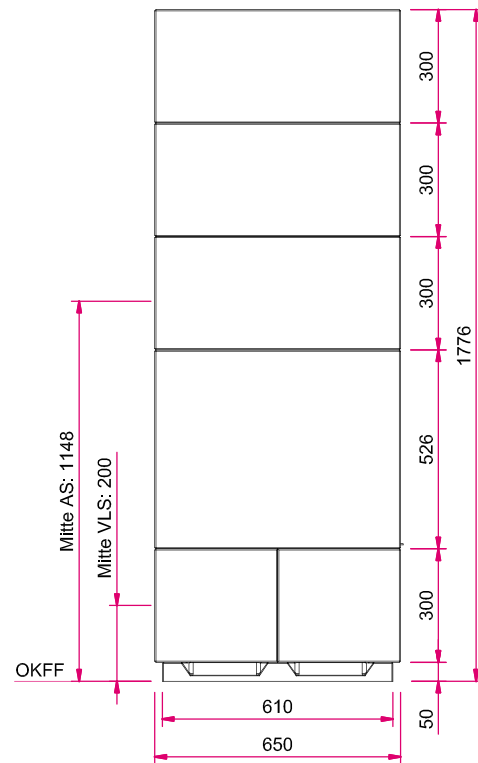

Hinweis: Mit **optionalem Zubehör** bitte die Angaben in den Preislisten beachten.
AS: Abgasstutzen, VLS: Verbrennungsluftstutzen, OKFF: Oberkante Fertigfußboden

Draufsicht M 1:20

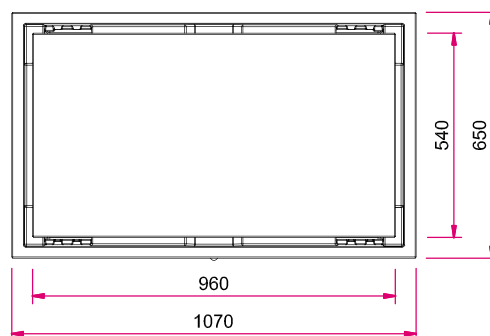

S7 Hoch mit Lina 5551 s Speicherstein



Abbildung: S7 Hoch mit Lina 5551 s
Oberflächenveredelung:
Camina Silikatanstrich

Abbildung: S7 Hoch mit Lina 5551 s in Kombination mit Designbeton
Oberflächenveredelung: Camina Silikatanstrich



Standard



Gesamtgewicht



Kamineinsatz

Lina 5551 s
NW-Leistung: 7 kW
Abgasstutzen: Ø 180 mm

Optional



Mehr Infos unter
camina-schmid.de

Zubehör



Speicherbeton



Speicherbeton



Designbeton

Frontansicht M 1:20

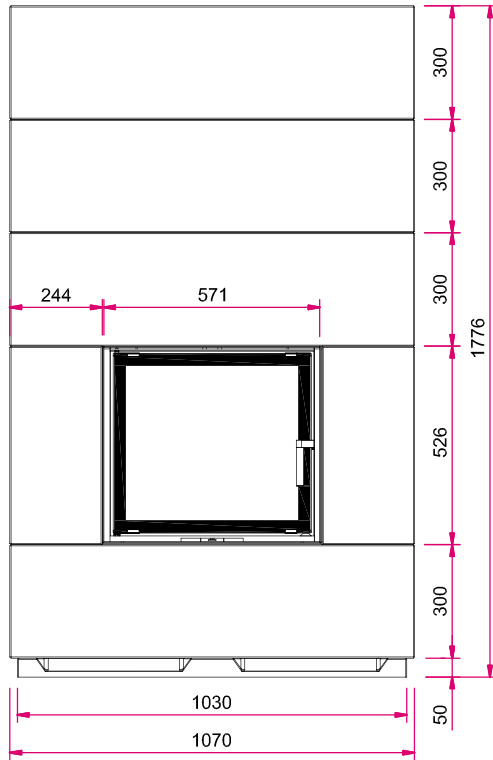

Seitenansicht links M 1:20

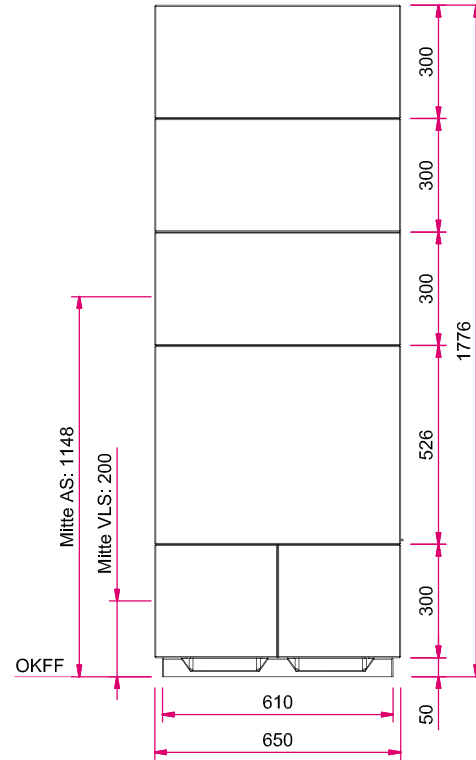

Hinweis: Mit **optionalem Zubehör** bitte die Angaben in den Preislisten beachten.
AS: Abgasstutzen, VLS: Verbrennungsluftstutzen, OKFF: Oberkante Fertigfußboden

Draufsicht M 1:20

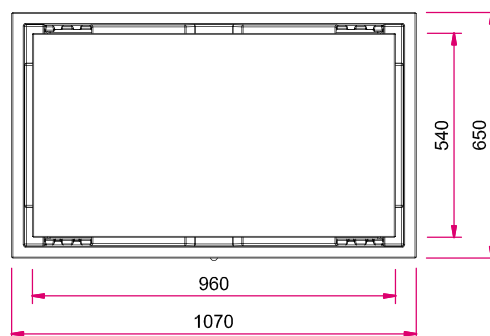

S7 Hoch mit Lina 6751 s

















Speicherstein



Abbildung: S7 Hoch mit Lina 6751 s in Kombination mit Designbeton
Oberflächenveredelung: Camina Silikatanstrich

Abbildung: S7 Hoch mit Lina 6751 s
Oberflächenveredelung: Camina Silikatanstrich



<p>Standard</p> <div style="display: flex; justify-content: space-around;"> <div style="text-align: center;">  <p>Tür schwenkbar Anschlag li./re.</p> </div> <div style="text-align: center;">  <p>Front Kristall</p> </div> </div>	<p>Gesamtgewicht</p> <div style="text-align: center;">  <p>kg ca. 707 kg</p> </div>	<p>Kamineinsatz</p> <p>Lina 6751 s NW-Leistung: 9 kW Abgasstutzen: Ø 180 mm</p> <div style="text-align: right;">  <div style="background-color: #90EE90; padding: 2px 5px; font-weight: bold; font-size: 12px;">A</div> <p>Mehr Infos unter camina-schmid.de</p> </div>
<p>Optional</p> <div style="display: flex; justify-content: space-between; align-items: flex-start;"> <div style="text-align: center;">  <p>Tür hochschiebbar</p> </div> <div style="text-align: center;">  <p>Front Anthrazit</p> </div> <div style="text-align: center;">  <p>Front Kristall + (nur Lina h)</p> </div> <div style="text-align: center;">  <p>Doppel- verglasung</p> </div> <div style="text-align: center;">  <p>Front veredelt</p> </div> <div style="text-align: center;">  <p>Front veredelt (komplett)</p> </div> </div>		
<p>Zubehör</p> <div style="display: flex; justify-content: space-around;"> <div style="text-align: center;">  <p>Aufsatz- speicher</p> </div> <div style="text-align: center;">  <p>SMR</p> </div> <div style="text-align: center;">  <p>Elektronischer Türantrieb (nur Lina h)</p> </div> <div style="text-align: center;">  <p>Vorlegeplatte</p> </div> </div>		
<p>Speicherbeton</p> <div style="display: flex; justify-content: space-around;"> <div style="text-align: center;">  <p>Speicherbeton</p> </div> <div style="text-align: center;">  <p>Designbeton</p> </div> </div>		

Maßzeichnungen S7 Hoch mit Lina 6751 s

Frontansicht M 1:20

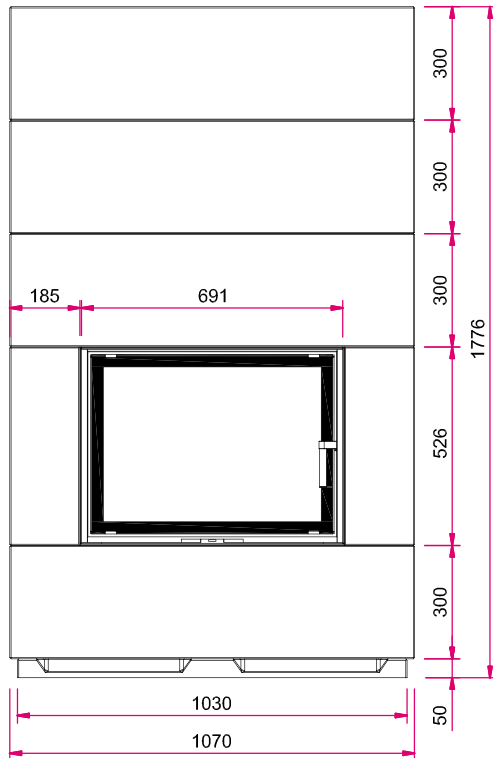

Seitenansicht links M 1:20

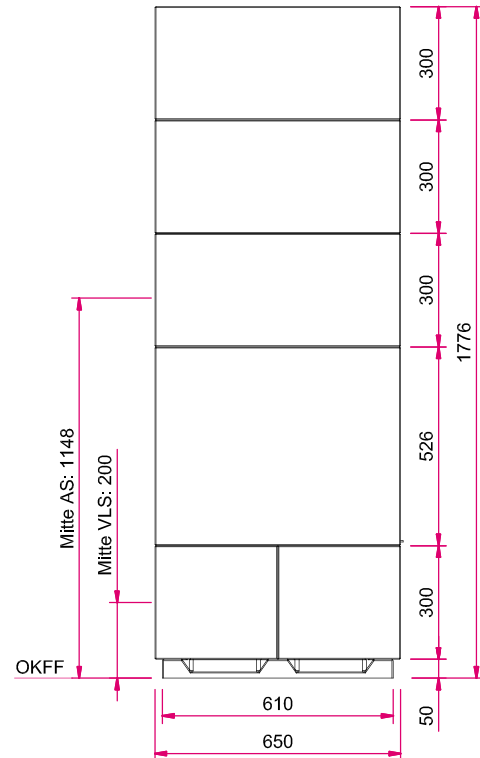

Hinweis: Mit **optionalem Zubehör** bitte die Angaben in den Preislisten beachten.
AS: Abgasstutzen, VLS: Verbrennungsluftstutzen, OKFF: Oberkante Fertigfußboden

Draufsicht M 1:20

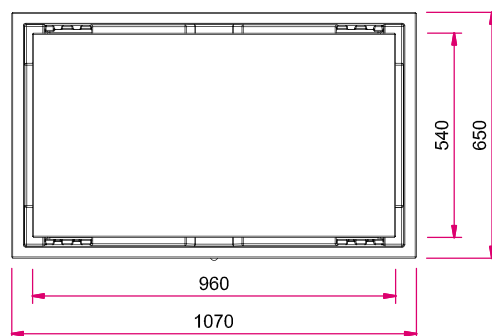

S7 Hoch mit Lina W 6751 s

Speicherstein

Camina
EXCLUSIVE FIREDESIGN



Abbildung: S7 Hoch mit Lina W 6751 s
in Kombination mit Designbeton
Oberflächenveredelung:
Camina Silikatanstrich

Abbildung: S7 Hoch mit Lina W 6751 s
Oberflächenveredelung: Camina Silikatanstrich



Standard

Tür schwenkbar
Anschlag li./re.

Front Kristall

Kesselgerät
Lina W

Gesamt-
gewicht

kg
ca.
757 kg

Kamineinsatz

Lina W 6751 s
NW-Leistung: 14,5 kW
Abgasstutzen: Ø 200 mm

Optional

Tür
hochschiebbar

Front
Anthrazit

Front veredelt

Front veredelt
(komplett)



A+

Mehr Infos unter
camina-schmid.de

Zubehör

Aufsatz-
speicher

Elektronischer
Türantrieb
(nur Lina h)

Vorlegeplatte

Speicherbeton



Speicherbeton



Designbeton

Frontansicht M 1:20

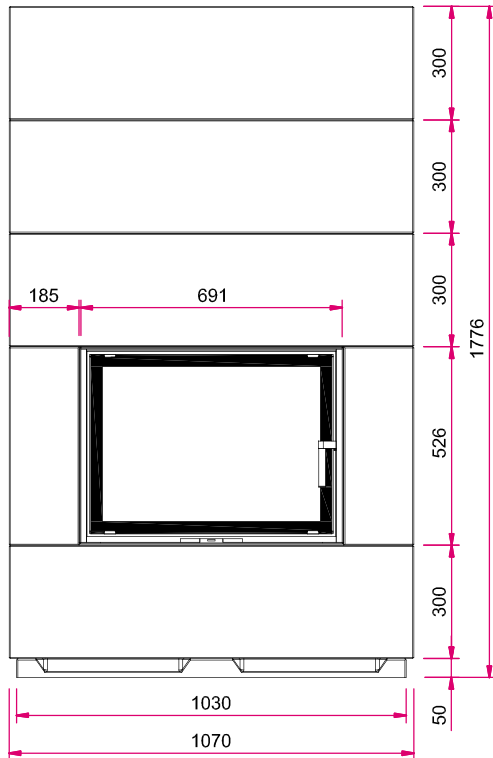

Seitenansicht links M 1:20

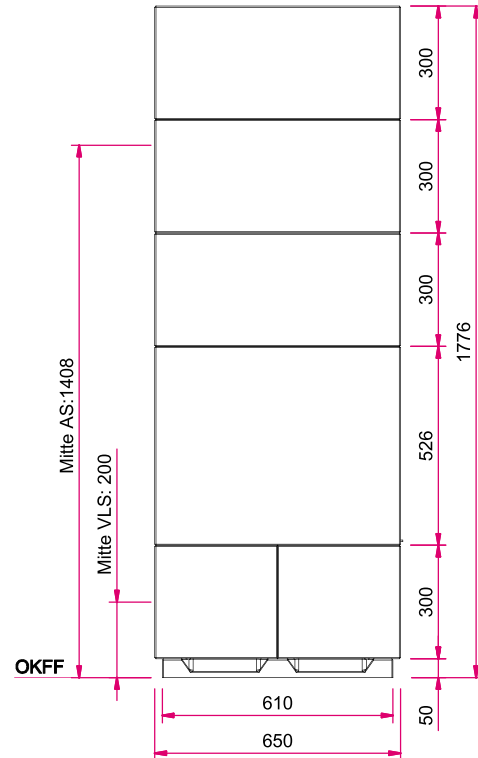

Hinweis: Mit **optionalem Zubehör** bitte die Angaben in den Preislisten beachten.
AS: Abgasstutzen, VLS: Verbrennungsluftstutzen, OKFF: Oberkante Fertigfußboden

Draufsicht M 1:20

